



P1J

Pressure Sensor

Description

The P1J series of pressure sensors incorporates a piezo-resistive sensing element in a compact package. Using a 2.7 to 5.5 VDC supply voltage, the P1J provides a SPI or I2C digital output as required by your application. Internal temperature compensation provides and accurate, easy to use sensor. The industry standard terminal pins provides ease of use for your printed circuit board designs.

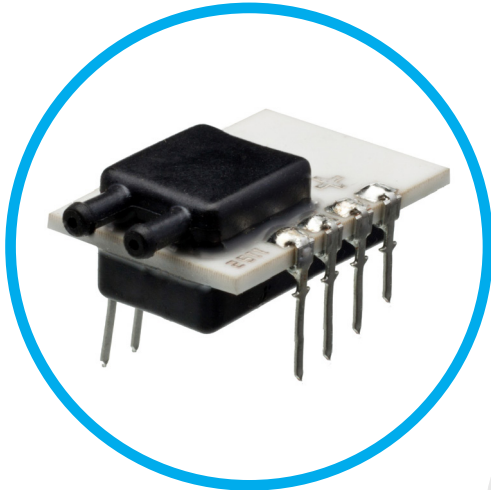

Features

- Compact Package
- Amplified Temperature Compensated Digital Output
- No Position Sensitivity above 0-2"H2O
- EMI/RFI and ESD Protected
- Superior Output Signal Stability
- Printed Circuit Board through Hole Mounting

Applications

- Variable Air Volume Systems
- Filter Pressure Monitoring
- Duct Air Flow
- Modulated Furnace Controls
- Combustion Airflow
- Gaseous Leak Detection
- **Medical Applications:**
Oxygen Concentrators, Ventilators, Anesthesia Equipment, CPAP, Wound Therapy.



MAIN FEATURES

Pressure Ranges	2, 5, 10, +/- 2, +/- 5, +/- 10 inches of water; 5, 12.5, 25, +/- 5, +/- 6, +/- 12.5, +/- 25 mbar
Electrical Connection	PCB thru hole terminal pins, 2.54 mm [.100 inch] pitch
Pressure Connection	Barbed port, 1.9[.08] diameter
Housing Material	PPS, 40% glass filled, black
Terminal Pin Material	Phosphor bronze, tin plated
Supply Voltage	2.7 to 5.5 VDC
Output Signal	14 Bit Digital Output Count – Digital count at null (0% FS): 1638 Digital count at full scale (100% FS) 14745



Pressure Ranges

from 0 to...	2" H2O	5" H2O	10" H2O	+/- 2" mBar	+/- 5" mBar
from 0 to...	5mbar	12.5mbar	20mbar	+/- 5mbar	+/- 12.5 mbar
Proof Pressure Factor	1.0 PSI/ (70mbar)	1.0 PSI/ (70mbar)	1.0 PSI/ (70mbar)	1.0 PSI/ (70mbar)	1.0 PSI/ (70mbar)
Burst Pressure Factor	1.8 PSI/ (125mbar)	1.8 PSI/ (125mbar)	1.8 PSI/ (125mbar)	1.8 PSI/ (125mbar)	1.8 PSI/ (125mbar)

Physical

Expected Operating Life	10 million full pressure life cycles
Shelf Life	10 years minimum
Stability	+/- 0.5% of full scale span for 1 year
Vibration	10 G's peak to peak sinusoidal (20 to 1600Hz)
Shock Resistance	50 G's ½ Sinewave, 11 mSec pulse, 18 pulses (6 per axis)
Weight	3.5g max.
Operating Temperature	-20°C to 85°C
Storage Temperature	-40°C to 85°C
Humidity	Up to 92% RH in a non-condensing environment
Media	Dry air

Performance

Accuracy	0.25% Max (% of full scale span) (RSS of linearity, hysteresis and repeatability)
Temp. Error	0.05%/ C [% of full scale span]
Temp. Error	5% full scale span within temperature range -20° to 0°C and 60° to 85°C 0 to 60°C

Electrical

Input Voltage Protection	-0.3 to 6 VDC on Vin PIN, -0.3 to Vs+0.3 on all other pins
Excitation Current	< 2.5mA
Minimum Load	25k Ohms between output and ground
Response Time	0.5 ms



DIMENSIONS

Dimensions in mm [Inch]

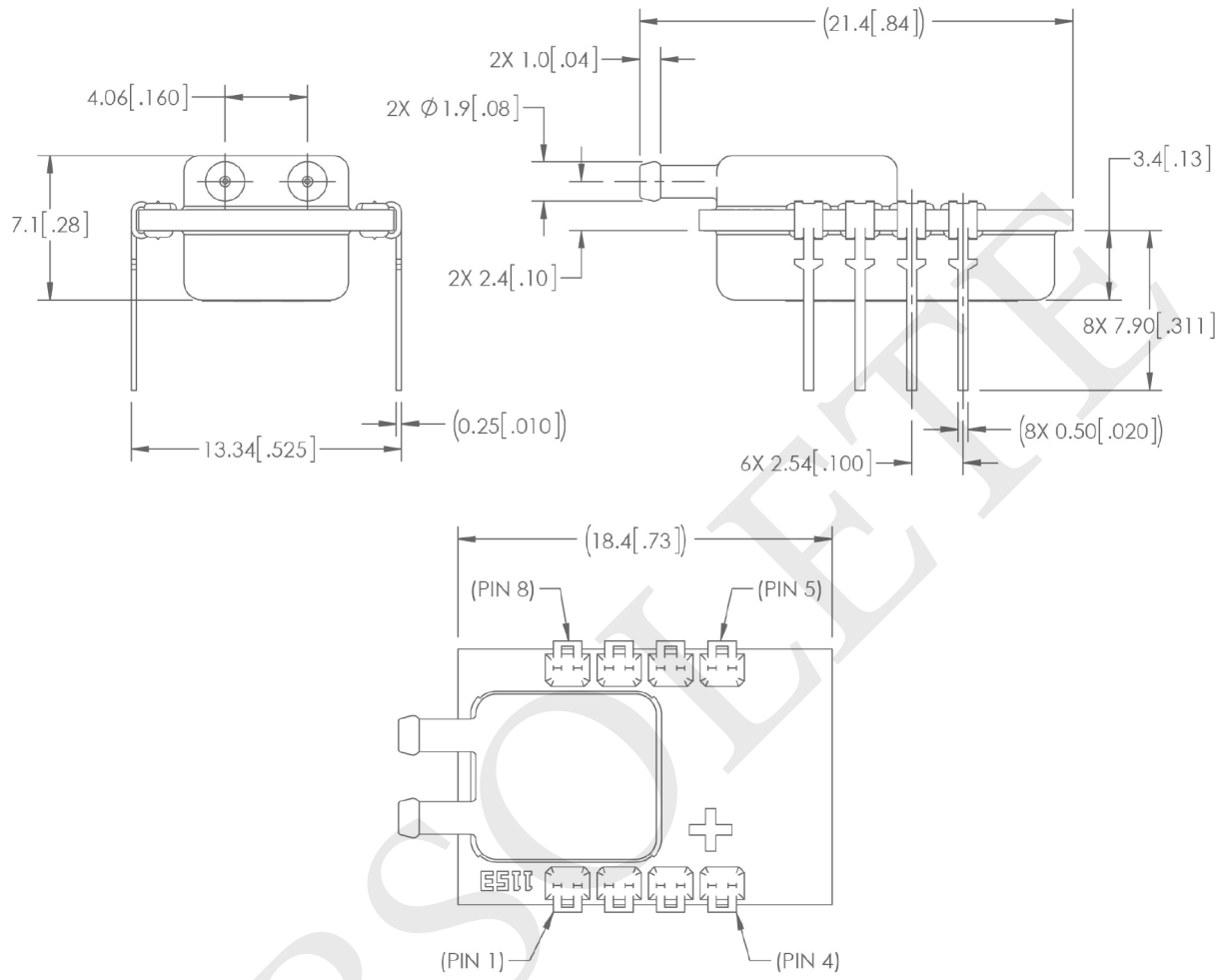

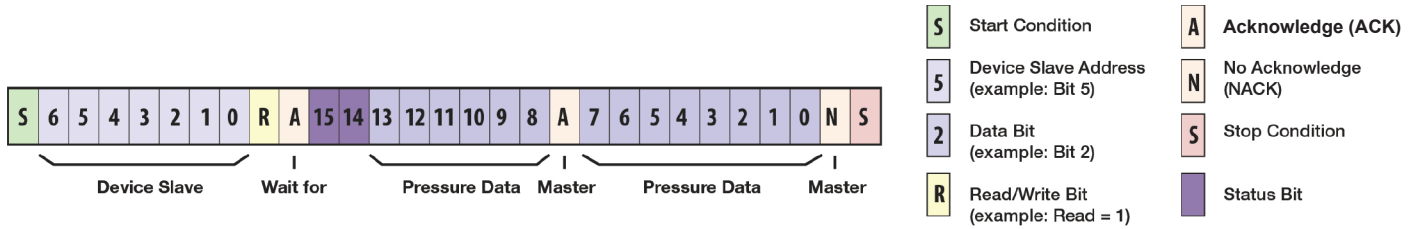

Output

Signal Resolution	12 Bits (11 bits minimum for 0-2" H2O and 0-5 mBar range)			
Update Rate	0.5 ms			
Digital Count at 0% Pressure	1638 (10% of 2 ¹⁴ counts or 0x666)			
Digital Count at 100% Pressure	14745 (90% of 2 ¹⁴ counts or 0x3999)			
Sensor Slave Addresses	40 (0x28), 56 (0x38), 72 (0x48), 88 (0x58), 104 (0x68), 120 (0x78)			
PARAMETER	SYMBOL	MIN	MAX	UNITS
Analog Supply Voltage to Gnd	VDD	2.7	5.5	V
High-level input voltage	VIH	0.8 × VDD	VDD	V
Low-level input voltage	VIL	0	0.2 × VDD	V
High-level output voltage	VOH	VDD - 0.2	-	V
Low-level output voltage	VOL	-	0.2	V
Output Sourcing Current	IOH_SDA	-1.9	-4.8	mA
Output Sink Current	IOL_SDA	2.3	6.2	mA
Load Capacitance at SDA (@ 400 kHz)	CSDA		200	pF
Pull-up Resistor	RI2C_PU	500		Ω
Input Capacitance (each pin)	CI2C_IN		10	pF
SCL clock frequency	fSCL	100	400	kHz
START condition hold time relative to SCL range	tHDSTA	0.1	-	μs
Minimum SCL clock low width 1)	tLOW	0.6		μs
Minimum SCL clock high width 1)	tHIGH	0.6		μs
Start condition setup time relative to SCL edge	tSUSTA	0.1		μs
Data hold time on SDA relative to SCL edge	tHDDAT	0		μs
Data setup time on SDA relative to SCL edge	tSUDAT	0.1		μs
Stop condition setup time on SCL	tSUSTO	0.1		μs
Bus free time between stop condition and start condition	tBUS	2		μs

1) Combined low and high widths must equal or exceed minimum SCLK period.



I2C TIMING DIAGRAM

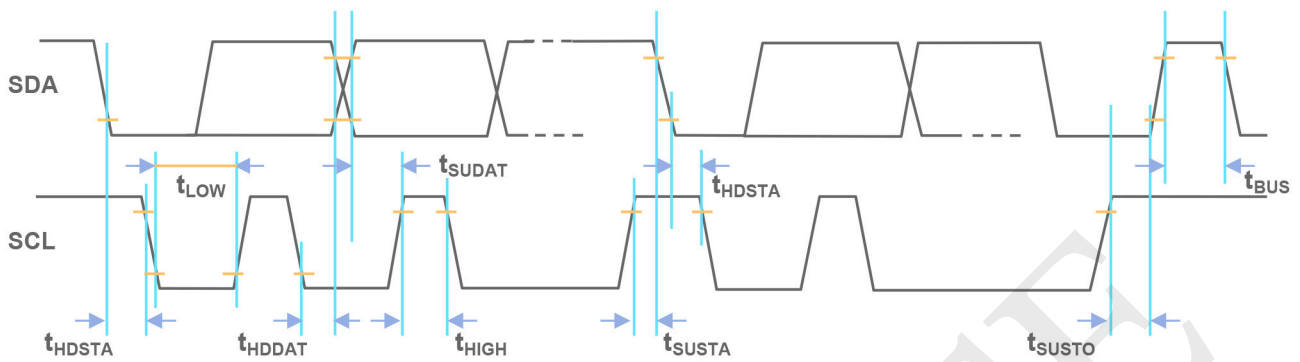

Note

There are three adjustments to the I2C implementation compared with the original I2C™ protocol:

- Sending a start-stop condition without any transitions on the CLK line (no clock pulses in between) creates a communication error for the next communication, even if the next start condition is correct and the clock pulse is applied. An additional start condition must be sent, which results in restoration of proper communication.
- The restart condition—a falling SDA edge during data transmission when the CLK clock line is still high—creates the same situation. The next communication fails, and an additional start condition must be sent for correct communication.
- A falling SDA edge is not allowed between the start condition and the first rising SCL edge. If using an I2C™ address with the first bit 0, SDA must be held low from the start condition through the first bit.

Output Packet with Positive Edge Sampling

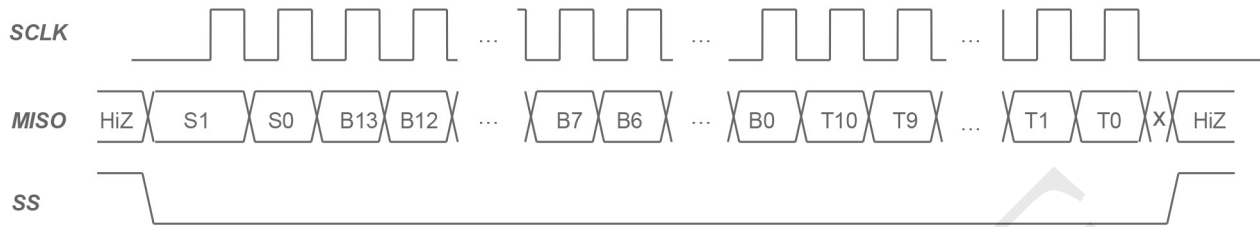

Packet = [{S(1:0)}, {B(13:8)}, {B(7:0)}, {T(10:3)}, {T(2:0)},xxxxx] Where
 S(1:0) = Status bits of packet (normal, command, busy, diagnostic)
 B(13:8) = Upper 6 bits of 14-bit bridge data
 B(7:0) = Lower 8 bits of 14-bit bridge data
 T(10:0) = NOT corrected temperature data (mask out or terminate read early)

Output

Signal Resolution	12 Bits (11 bits minimum for 0-2" H2O and 0-5 mBar range)			
Update Rate	0.5 ms			
Digital Count at 0% Pressure	1638 (10% of 214 counts or 0x666)			
Digital Count at 100% Pressure	14746 (90% of 214 counts or 0x3999)			
PARAMETER	SYMBOL	MIN	MAX	UNITS
Analog Supply Voltage to Gnd	VDD	2.7	5.5	V
High-Level Input Voltage	VIH	0.8 × VDD	VDD	V
Low-Level Input Voltage	VIL	0	0.2 × VDD	V
High-Level Output Voltage	VOH	VDD - 0.2	-	V
Low-Level Output Voltage	VOL	-	0.2	V
Output Sourcing Current @ VOH	IOH_MISO	1.9	-4.8	mA
	IOH_SS	-0.63	-1.9	mA
Output Sink Current @ VOL	IOL_MISO	2.3	6.2	mA
	IOL_SS	0.85	3.0	mA
Input Capacitance (Each Pin)	CI2C_IN		10	pF
SCLK Clock Frequency (4 MHz clock)	fSCL	50	800	kHz
SCLK Clock Frequency (1 MHz clock)	tSCL	50	200	kHz
SS Drop to First Clock Edge	tHDSS	2.5		µs
Minimum SCL Clock Low Width 1)	tLOW	0.6		µs
Minimum SCL Clock High Width 1)	tHIGH	0.6		µs
Clock Edge to Data Transition	tCLKD	0	0.1	µs
Rise of SS Relative to Last Clock Edge	tSUSS	0.1		µs
Bus Free Time Between Rise and Fall of SS	tBUS	2		µs

1) Combined low and high widths must equal or exceed minimum SCLK period.



SPI TIMING DIAGRAM

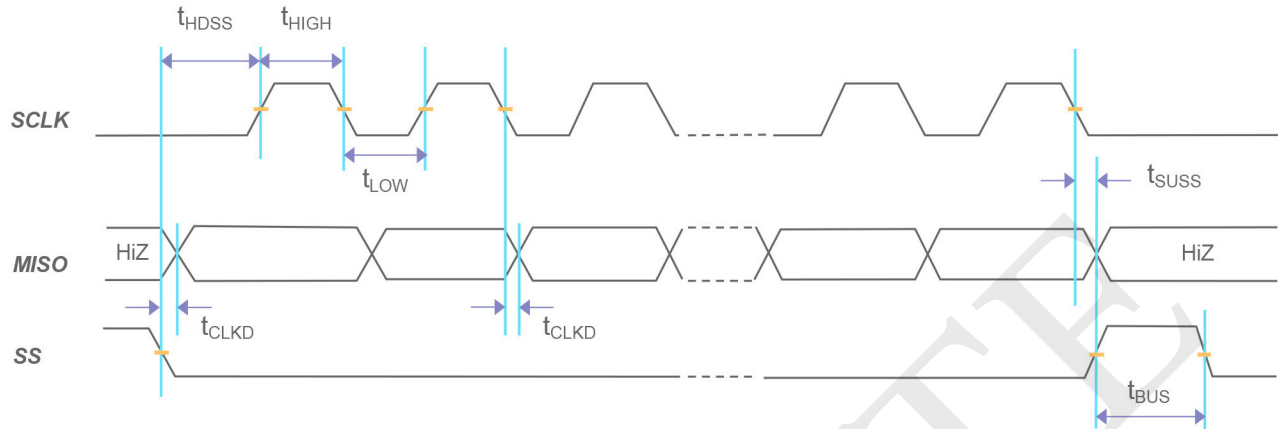

Note

The MISO line is setup to change state on the falling edge of the SCLK clock. Accordingly, the master should sample the data on the rising edge of the SCLK signal.



I2C/SPI DIAGNOSTIC FEATURES

The P1J offers a full suite of diagnostic features to ensure robust system operation. The diagnostic states are indicated by a transmission of the status of the 2 MSBs of the bridge high byte data or by a saturated output at 3FFFH.

STATUS BITS (2 MSB'S OF OUTPUT PACKAGE)	DEFINITION
Signal resolution	12 Bits (11 bits minimum for 0-2" H ₂ O and 0-5 mBar range)
Update rate	0.5 ms
Digital count at 0% pressure	1638 (10% of 214 counts or 0x666)
Digital count at 100% pressure	14746 (90% of 214 counts or 0x3999)

When the two MSBs are 11, one of the following faults listed below is indicated.

- Invalid EEPROM signature
- Loss of bridge positive or negative
- Bridge input short
- Loss of bridge source
- Loss of bridge sink

All diagnostics are detected in the next measurement cycle and reported in the subsequent data fetch. Once a diagnostic is reported, the diagnostic status bits will not change unless both the cause of the diagnostic is fixed and a power-on-reset is performed.



ORDERING OPTIONS

Example : P1J-2-AX16PA

P1J Pressure sensor 0 -1" H2O, I2C 28 Hex digital output, no internal material seal, barbed tube fitting port with PCB Terminal Pin connection, no external material seal.

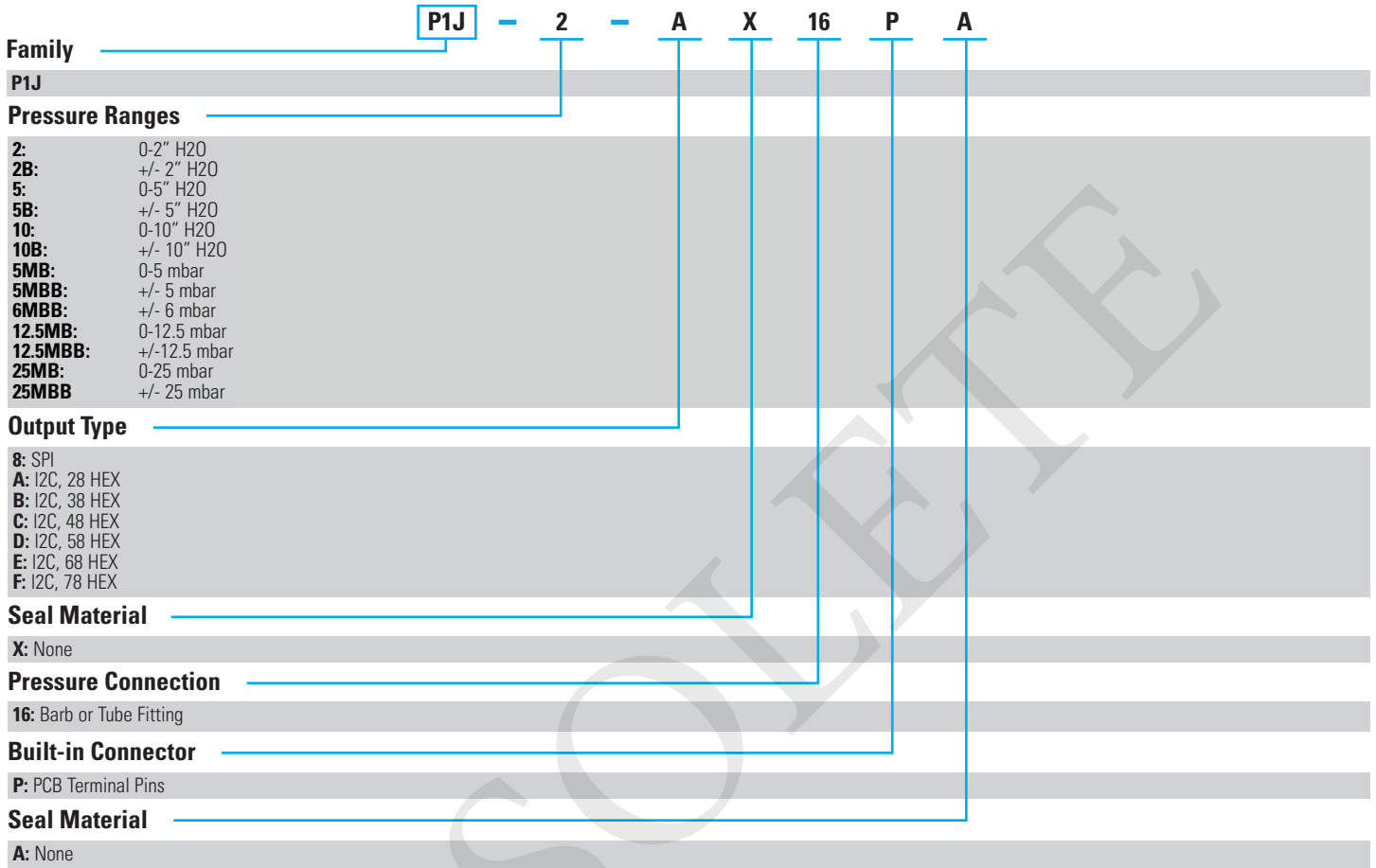



OBSOLETE

Sensata Technologies, Inc. ("Sensata") data sheets are solely intended to assist designers ("Buyers") who are developing systems that incorporate Sensata products (also referred to herein as "components"). Buyer understands and agrees that Buyer remains responsible for using its independent analysis, evaluation and judgment in designing Buyer's systems and products. Sensata data sheets have been created using standard laboratory conditions and engineering practices. Sensata has not conducted any testing other than that specifically described in the published documentation for a particular data sheet. Sensata may make corrections, enhancements, improvements and other changes to its data sheets or components without notice.

Buyers are authorized to use Sensata data sheets with the Sensata component(s) identified in each particular data sheet. HOWEVER, NO OTHER LICENSE, EXPRESS OR IMPLIED, BY ESTOPPEL OR OTHERWISE TO ANY OTHER SENSATA INTELLECTUAL PROPERTY RIGHT, AND NO LICENSE TO ANY THIRD PARTY TECHNOLOGY OR INTELLECTUAL PROPERTY RIGHT, IS GRANTED HEREIN. SENSATA DATA SHEETS ARE PROVIDED "AS IS". SENSATA MAKES NO WARRANTIES OR REPRESENTATIONS WITH REGARD TO THE DATA SHEETS OR USE OF THE DATA SHEETS, EXPRESS, IMPLIED OR STATUTORY, INCLUDING ACCURACY OR COMPLETENESS. SENSATA DISCLAIMS ANY WARRANTY OF TITLE AND ANY IMPLIED WARRANTIES OF MERCHANTABILITY, FITNESS FOR A PARTICULAR PURPOSE, QUIET ENJOYMENT, QUIET POSSESSION, AND NON-INFRINGEMENT OF ANY THIRD PARTY INTELLECTUAL PROPERTY RIGHTS WITH REGARD TO SENSATA DATA SHEETS OR USE THEREOF.

All products are sold subject to Sensata's terms and conditions of sale supplied at www.sensata.com SENSATA ASSUMES NO LIABILITY FOR APPLICATIONS ASSISTANCE OR THE DESIGN OF BUYERS' PRODUCTS. BUYER ACKNOWLEDGES AND AGREES THAT IT IS SOLELY RESPONSIBLE FOR COMPLIANCE WITH ALL LEGAL, REGULATORY AND SAFETY-RELATED REQUIREMENTS CONCERNING ITS PRODUCTS, AND ANY USE OF SENSATA COMPONENTS IN ITS APPLICATIONS, NOTWITHSTANDING ANY APPLICATIONS-RELATED INFORMATION OR SUPPORT THAT MAY BE PROVIDED BY SENSATA.

Mailing Address: Sensata Technologies, Inc., 529 Pleasant Street, Attleboro, MA 02703, USA.

CONTACT US

Americas

+1 (800) 350 2727
sensors@sensata.com
switches@sensata.com

Europe, Middle East & Africa

+359 (2) 809 1826
pressure-info.eu@sensata.com

Asia Pacific

sales.isasia@list.sensata.com
China +86 (21) 2306 1500
Japan +81 (45) 277 7117
Korea +82 (31) 601 2004
India +91 (80) 67920890
Rest of Asia +886 (2) 27602006
ext 2808